

62.001

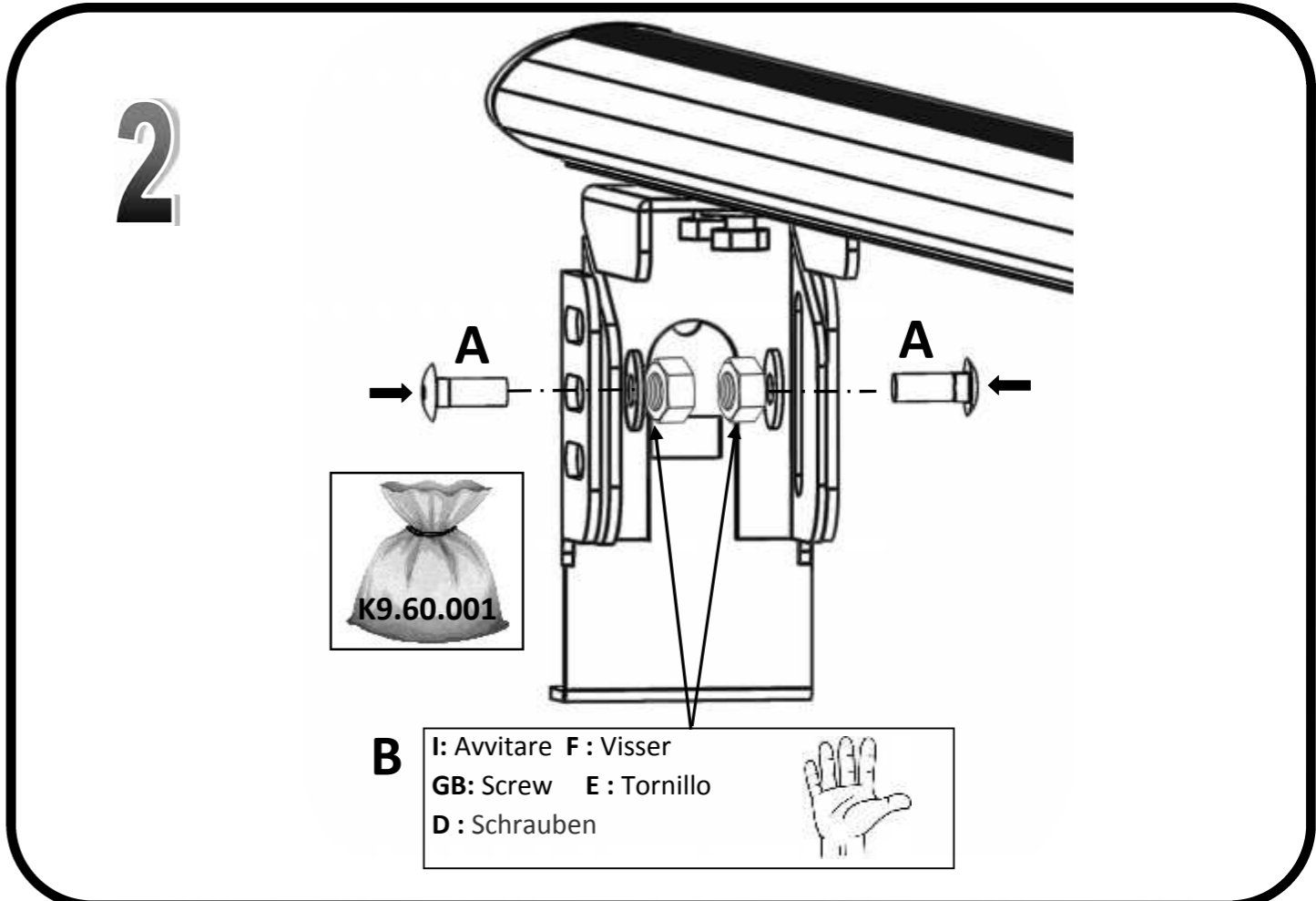

I : Istruzioni di montaggio
GB : Fitting instruction
D : Montageanleitung
F : Instructions de montage
E : Instrucciones de montaje

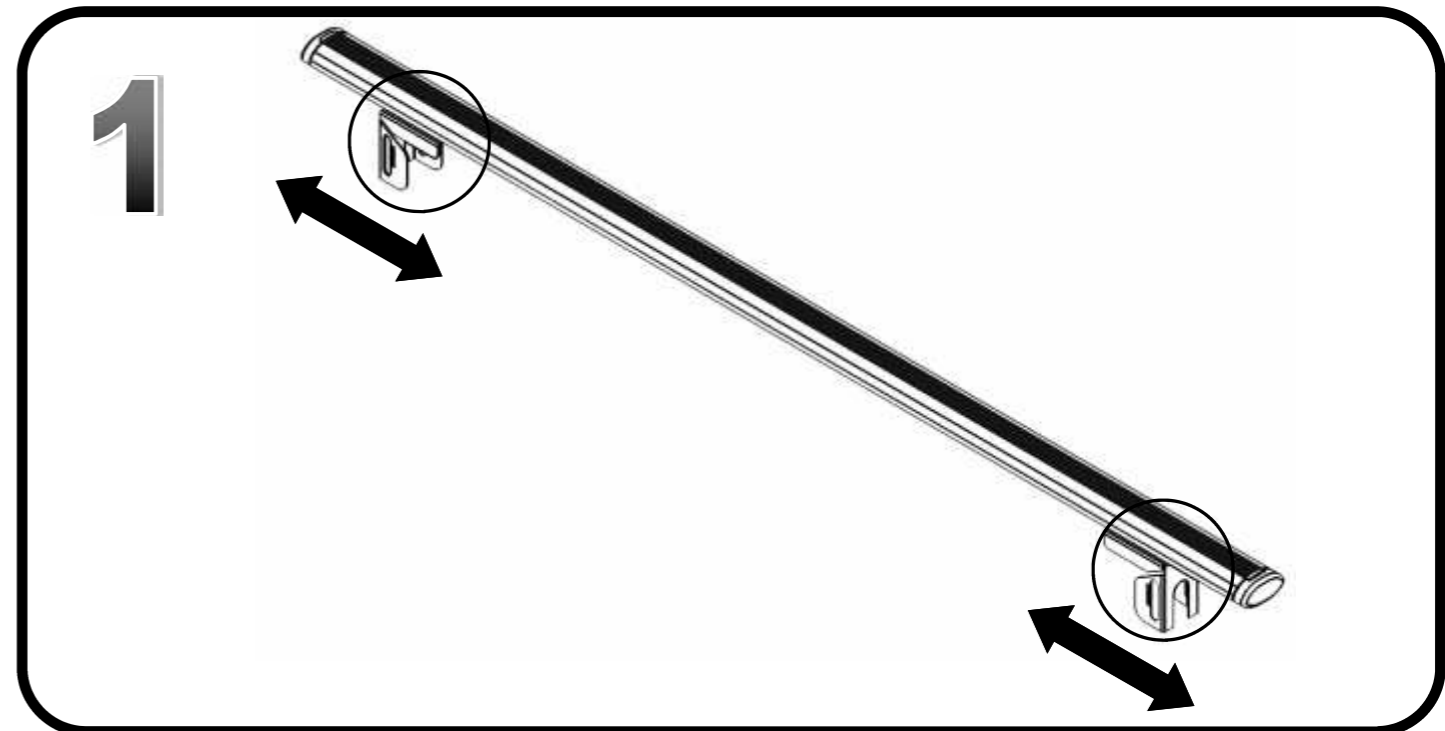

G3 Spa - via S. Allende, n 15
42020 Montecavolo di Quattro Castella
Reggio E: - Italy
Tel ++39 0522 880635
Fax ++39 0522 880306
www.g3spa.it - info@g3spa.it

COD. AO.214
REV. 00

3/A

FIAT: Doblò (>09) barra anteriore-centrale-posteriore.

FIAT: Doblò Maxi(>09) barra anteriore-centrale-posteriore.

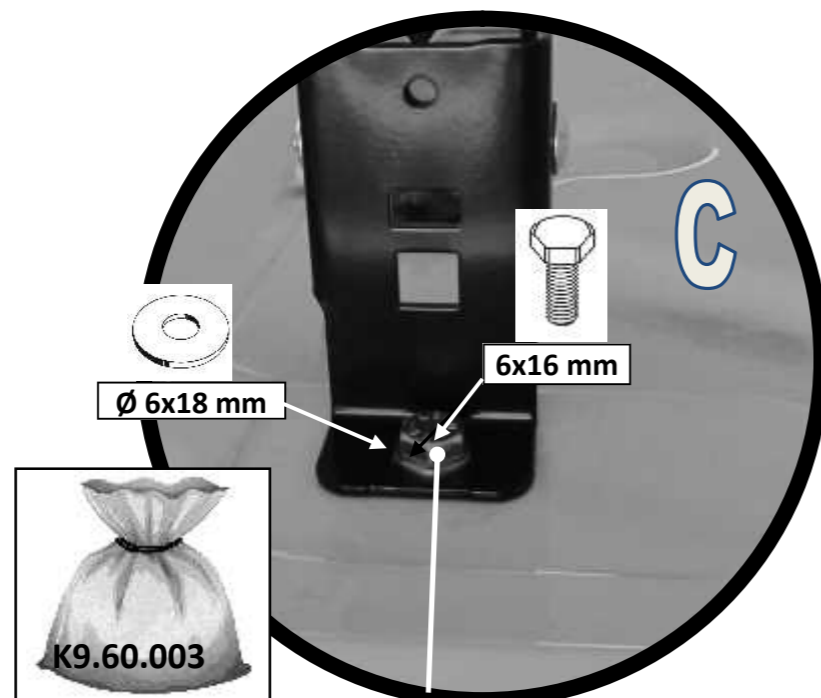
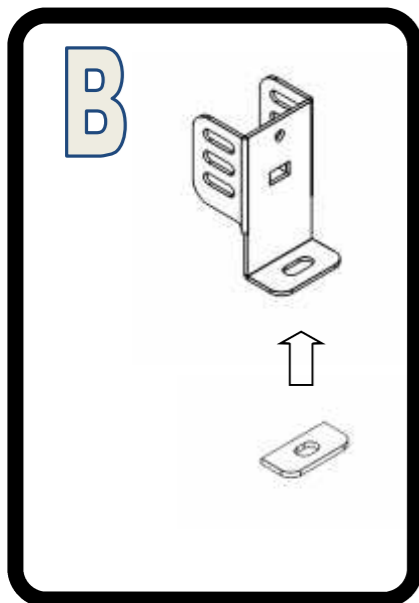
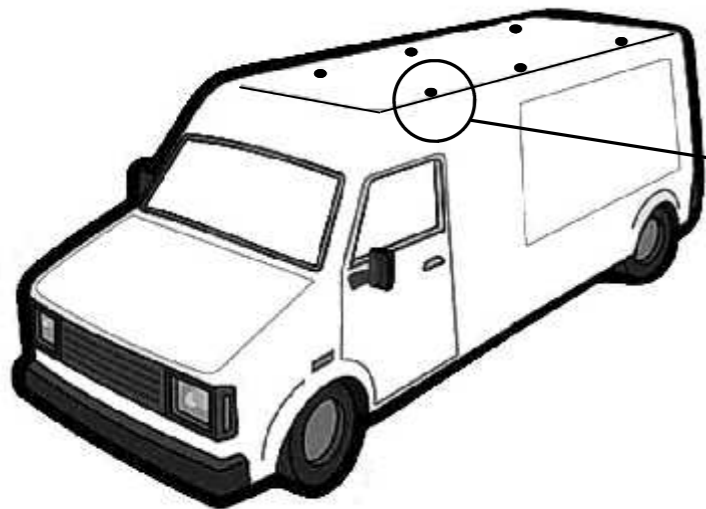

I: Avvitare F: Visser

GB: Screw E: Tornillo

D: Schrauben



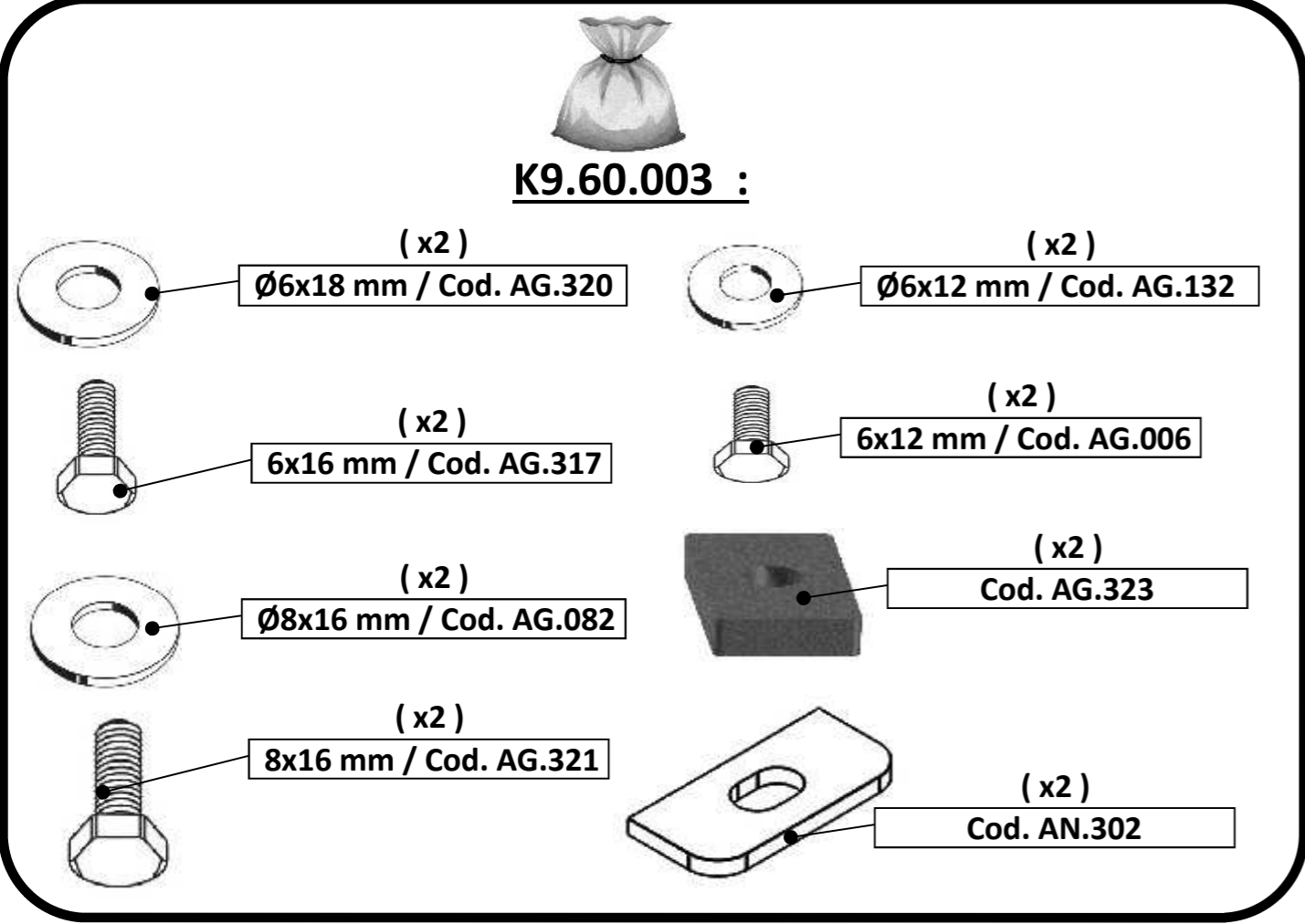
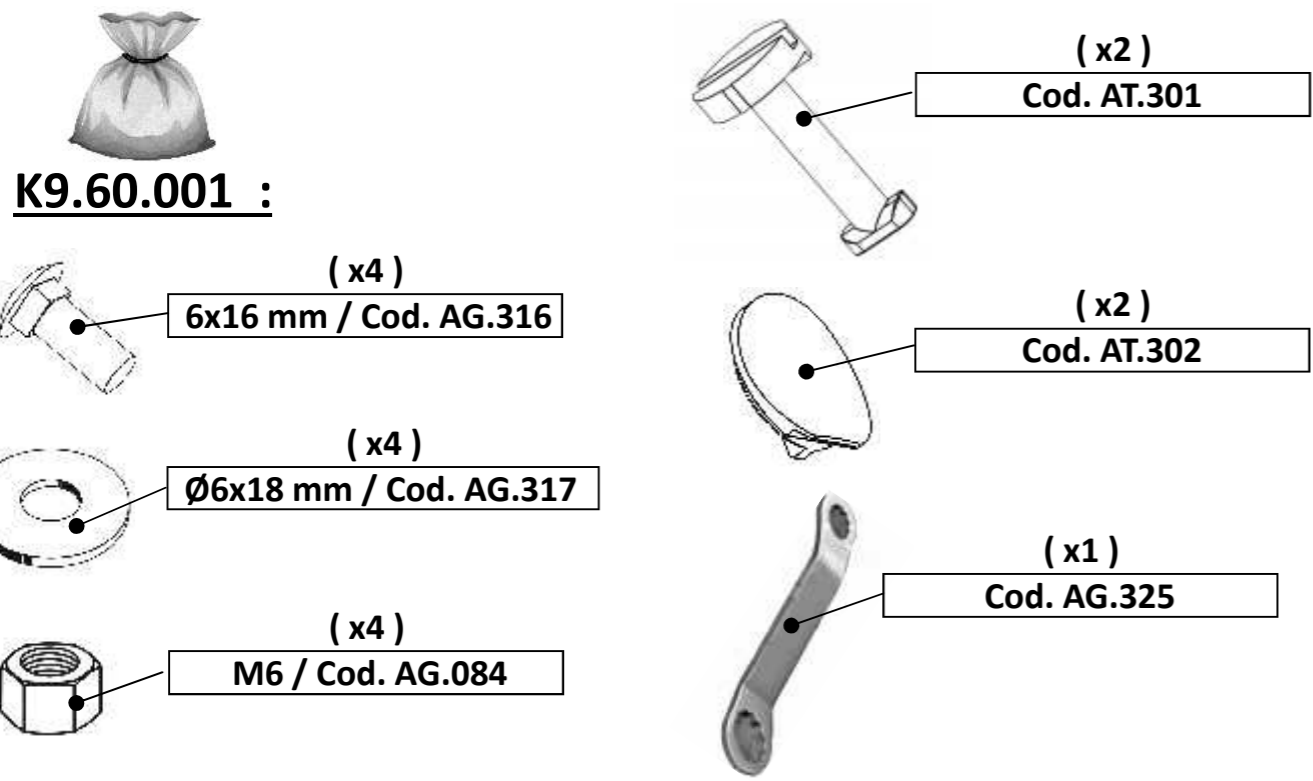

3/B

DACIA: Dokker barra anteriore - centrale - posteriore.
FORD: Transit Connect / Tourneo Connect vetrato.
MERCEDES: Citan maxi no rails barra anteriore - centrale - posteriore.
MERCEDES: Citan no rails barra anteriore e posteriore.
NISSAN: Evaglia / NV 200 barra anteriore - centrale - posteriore.
NISSAN: Kubistar barra anteriore e posteriore.
RENAULT: Kangoo barra anteriore e posteriore.
RENAULT: New Kangoo maxi no rails (08>) barra ant. - centr. - post.
RENAULT: New Kangoo no rails (08>) barra ant. - centr. - post.
VW: New Caddy (04>) barra anteriore e posteriore.
VW: New Caddy maxi (04>) barra anteriore - centrale - posteriore.

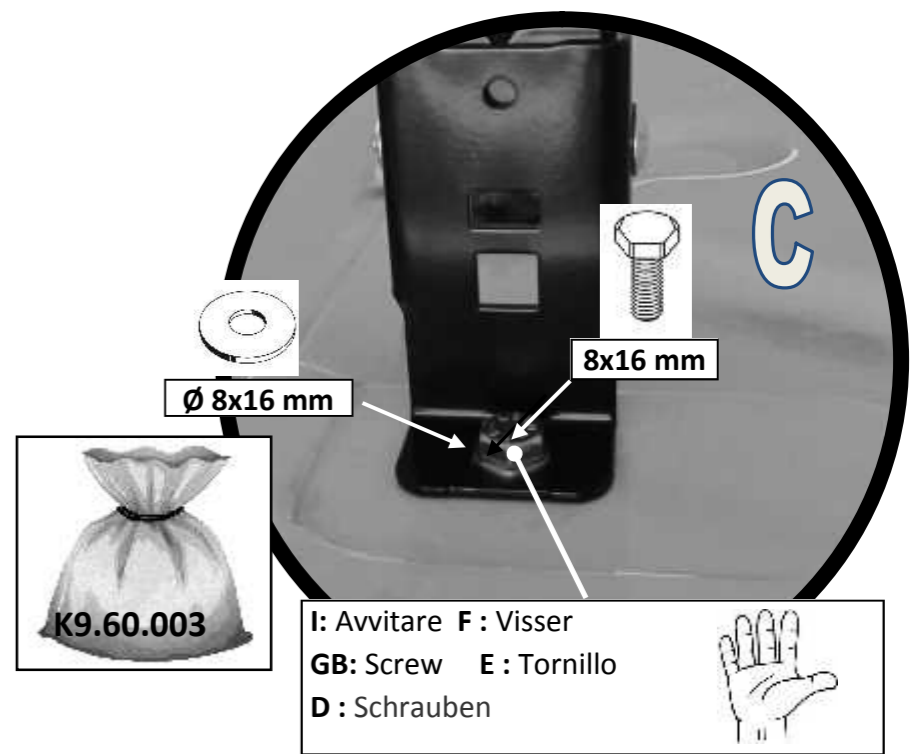
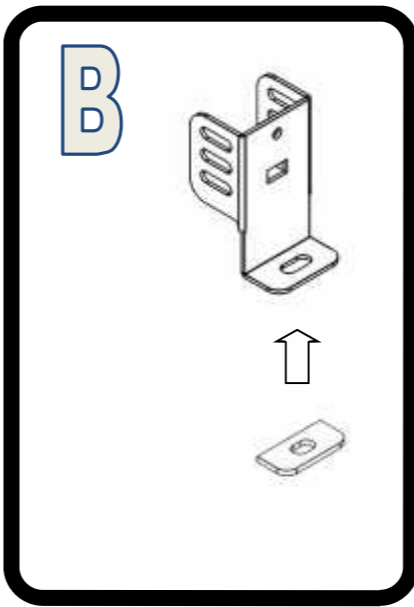
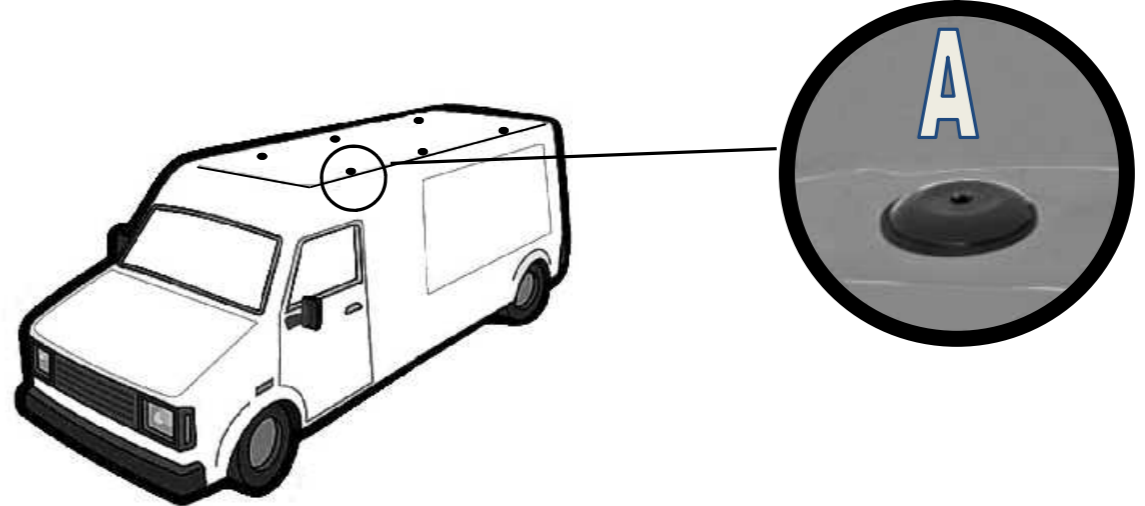

I: Avvitare F: Visser
 GB: Screw E: Tornillo
 D: Schrauben

3/C

CITROEN: Jumpy (07>) tetto alto.
PEUGEOT: Expert (07>) tetto alto.
FIAT: Scudo (07>) tetto alto.

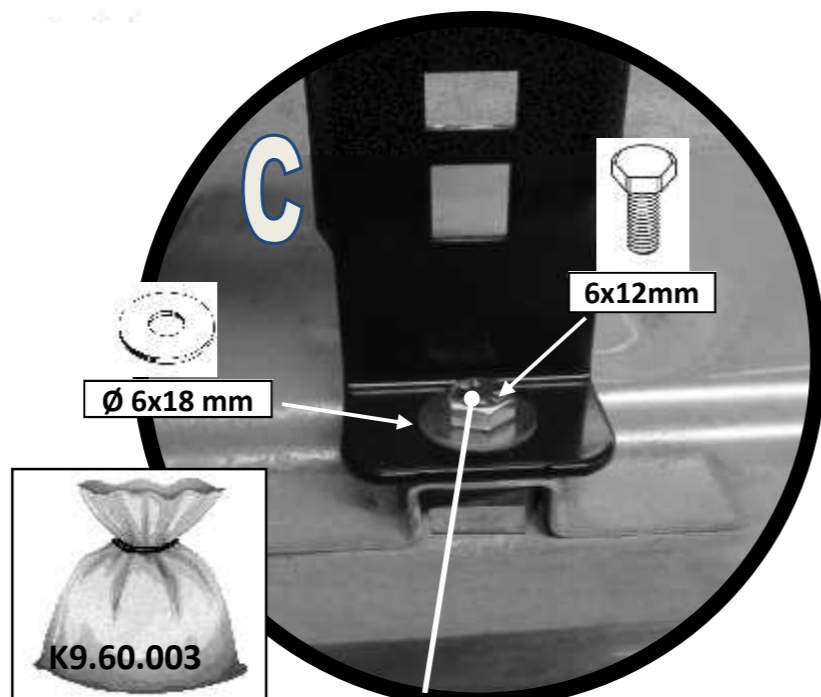
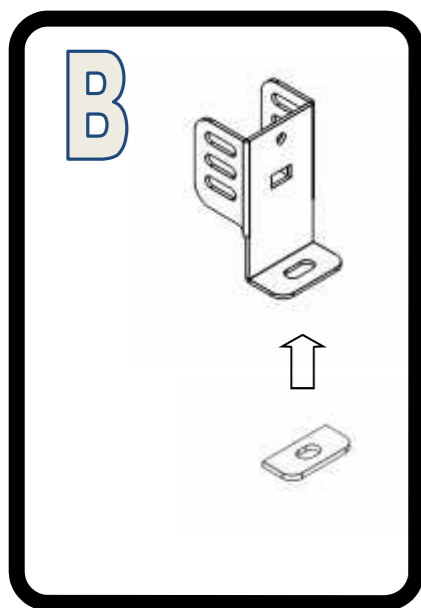
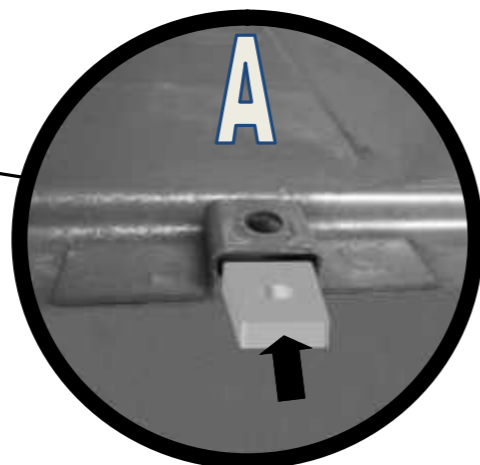
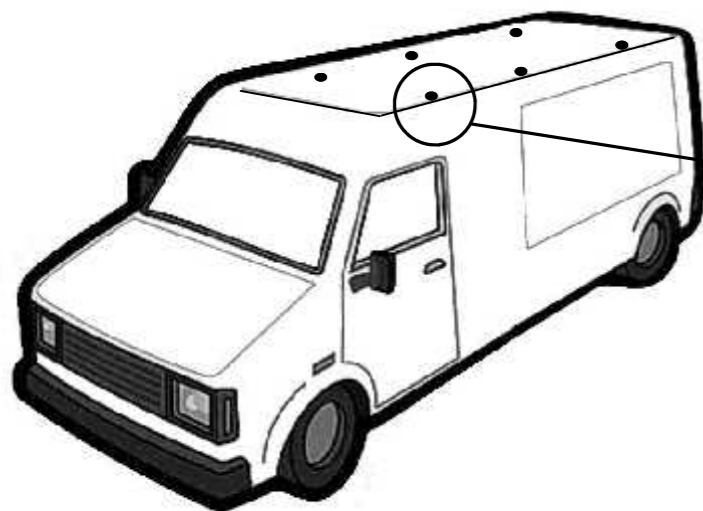

I: Avvitare F: Visser
GB: Screw E: Tornillo
D: Schrauben

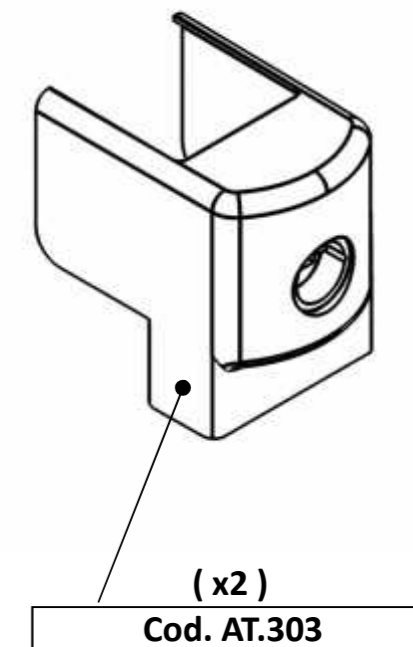
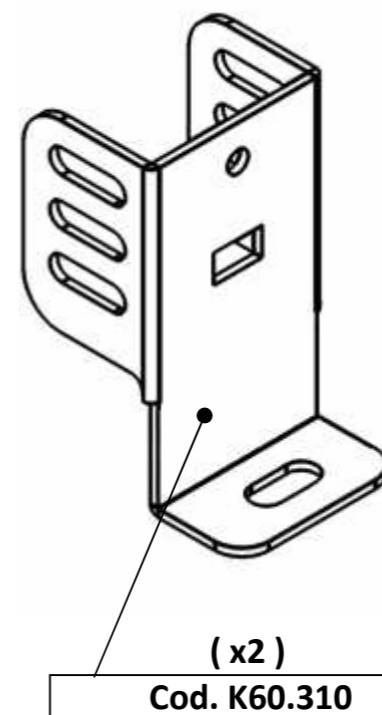
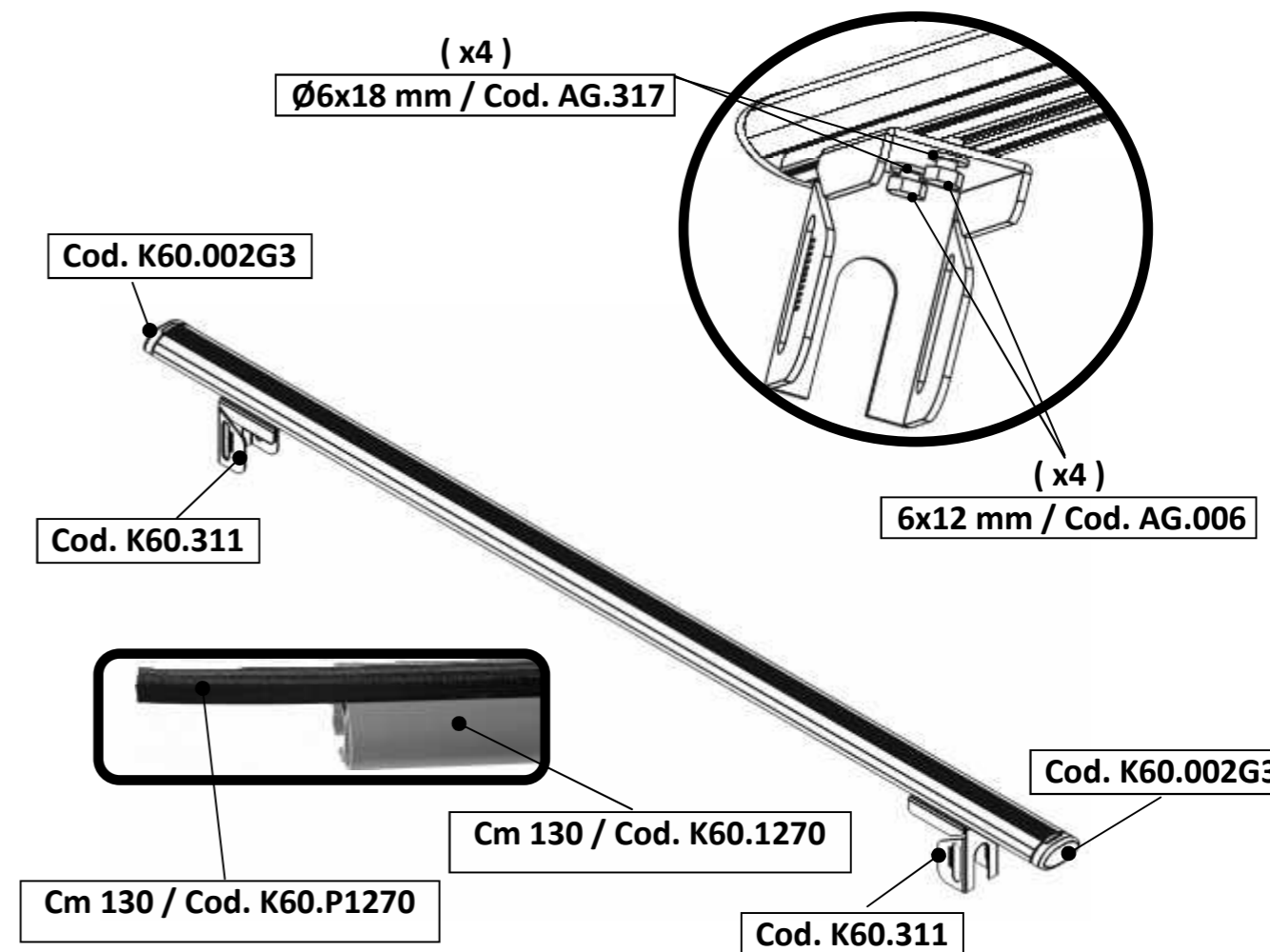

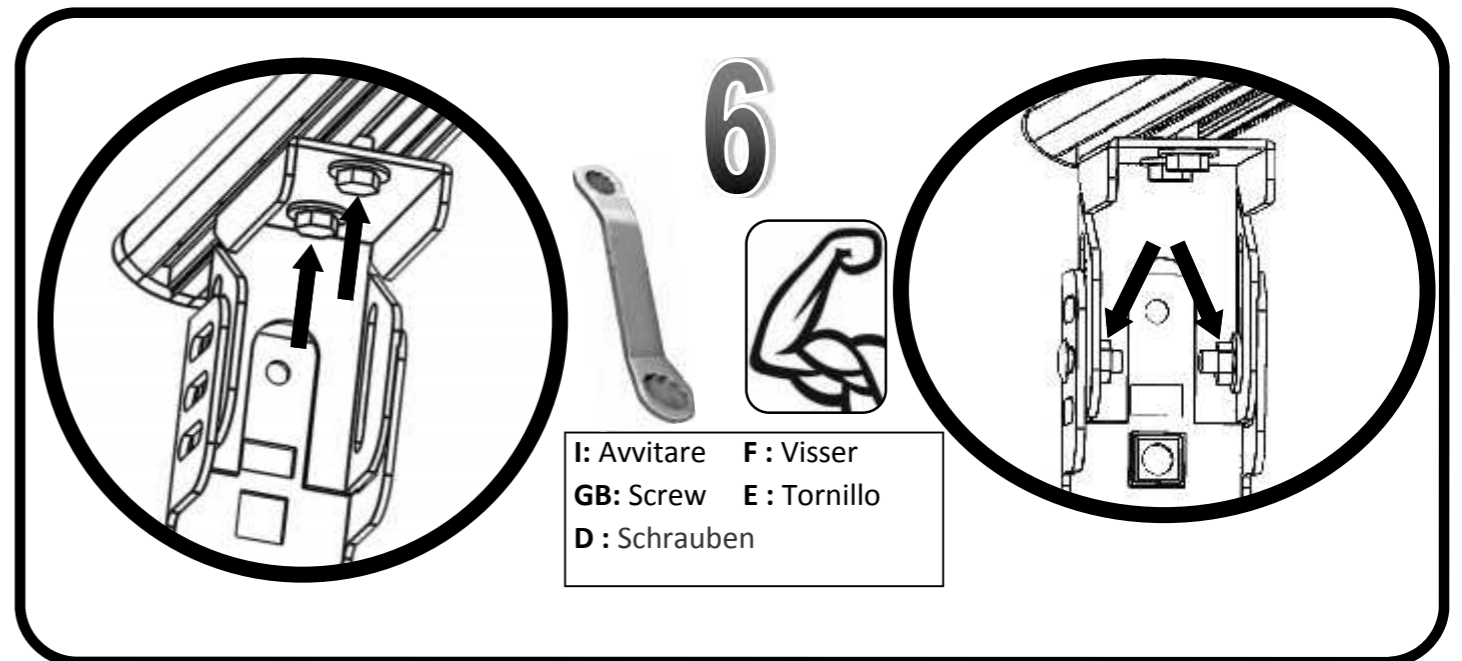
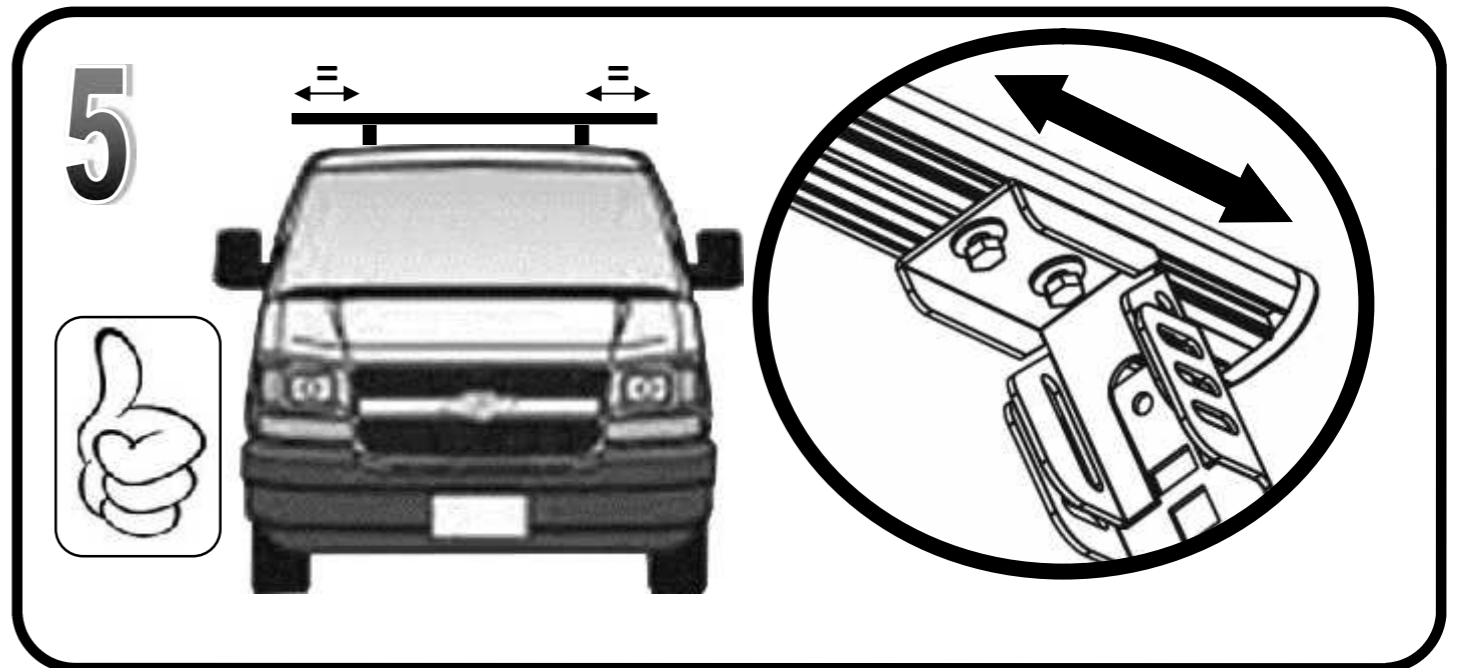
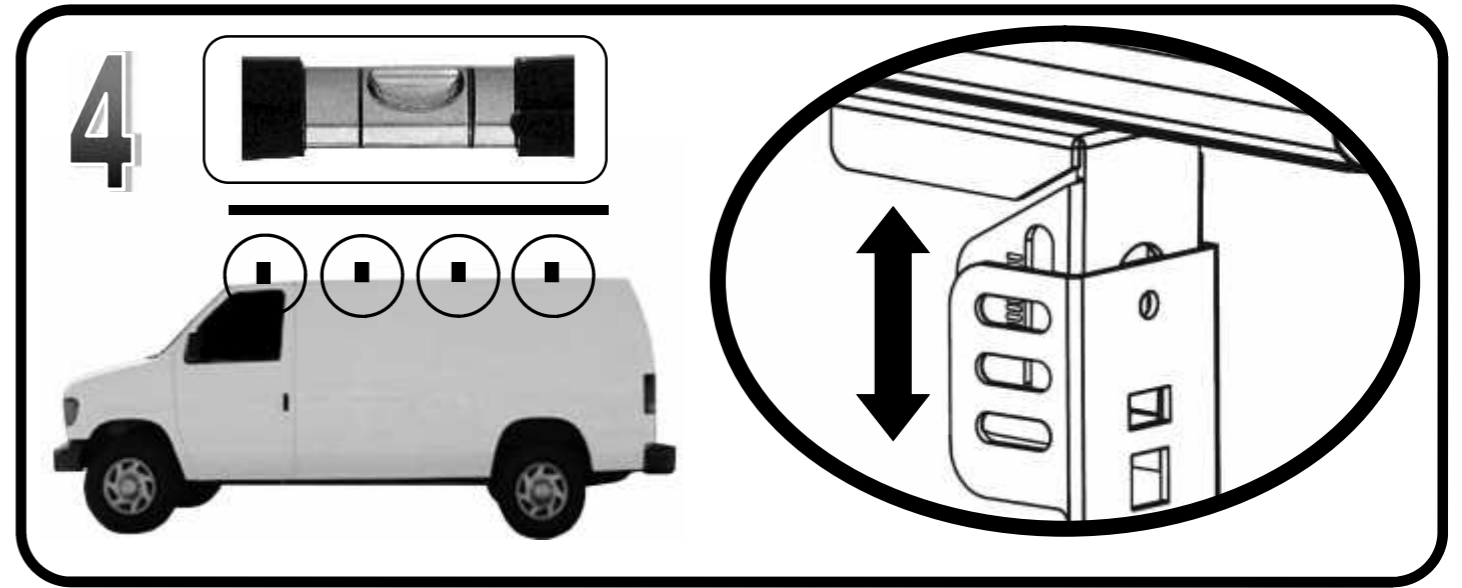
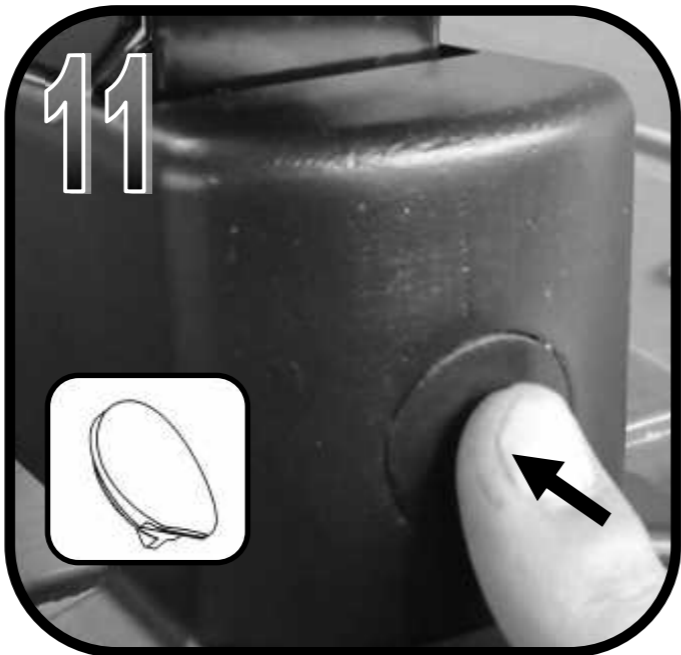
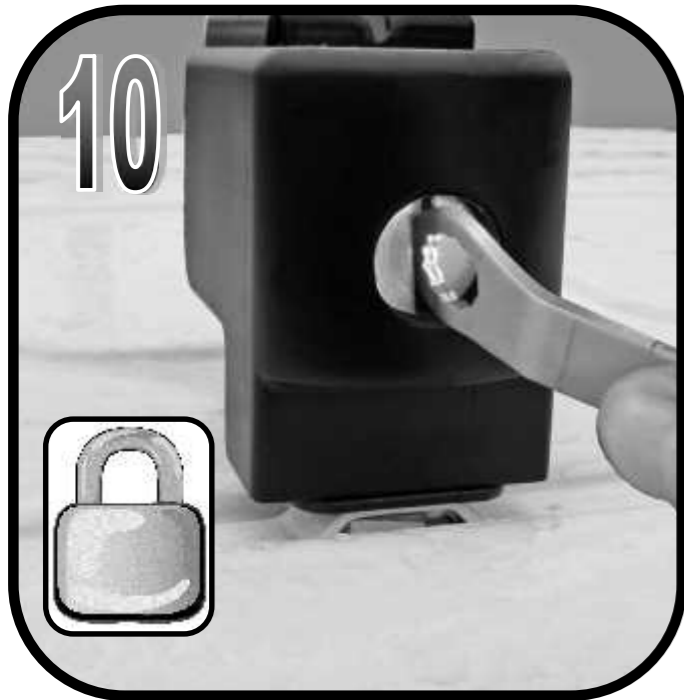
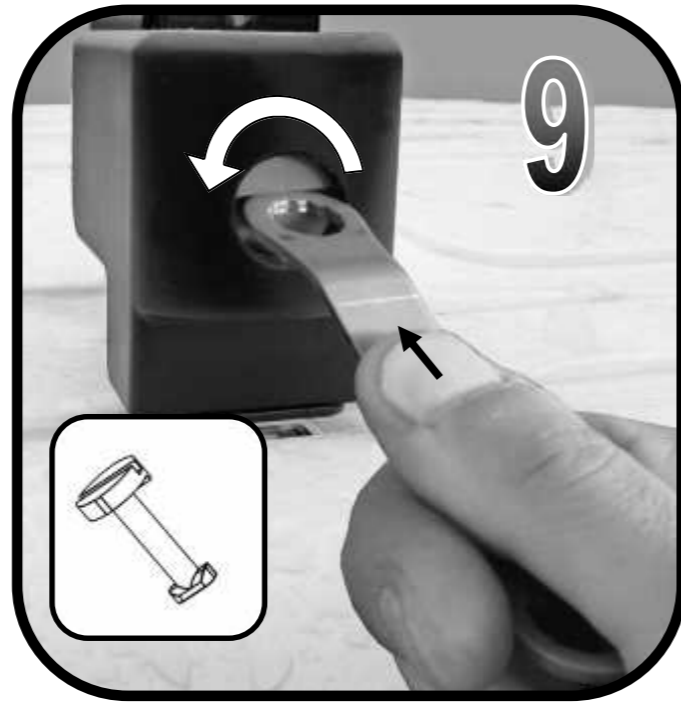
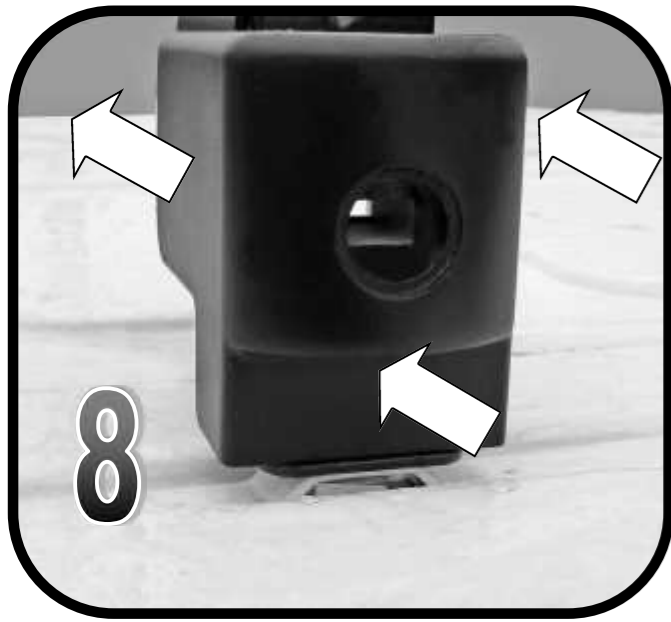

7/A

FIAT: Doblò (>09) barra anteriore-centrale-posteriore.
FIAT: Doblò Maxi(>09) barra anteriore-centrale-posteriore.

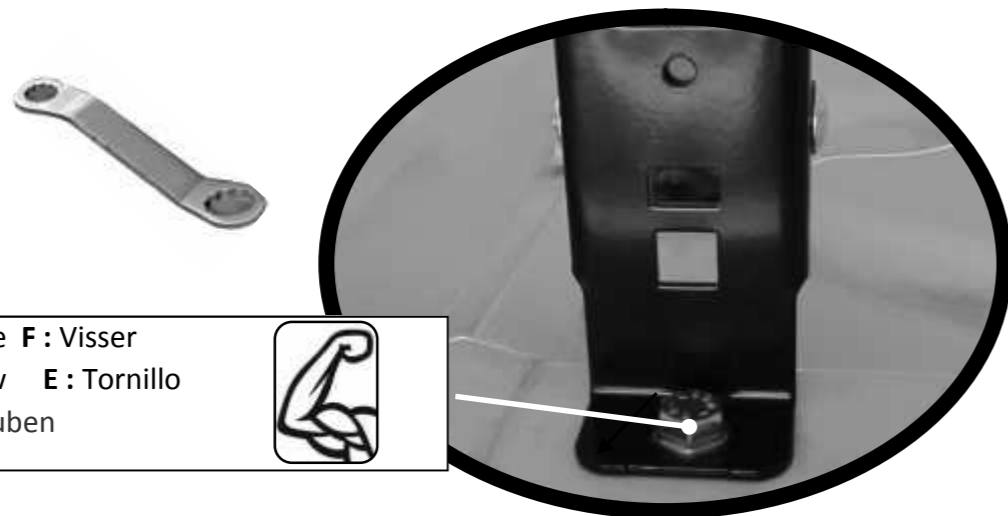

I: Avvitare F: Visser
GB: Screw E: Tornillo
D: Schrauben



7/B

DACIA: Dokker barra anteriore - centrale - posteriore.
FORD: Transit Connect / Tourneo Connect vetrato.
MERCEDES: Citan maxi no rails barra anteriore - centrale - posteriore.
MERCEDES: Citan no rails barra anteriore e posteriore.
NISSAN: Evaglia / NV 200 barra anteriore - centrale - posteriore.
NISSAN: Kubistar barra anteriore e posteriore.
RENAULT: Kangoo barra anteriore e posteriore.
RENAULT: New Kangoo maxi no rails (08>) barra ant. - centr. - post.
RENAULT: New Kangoo no rails (08>) barra ant. - centr. - post.
VW: New Caddy (04>) barra anteriore e posteriore.
VW: New Caddy maxi (04>) barra anteriore - centrale - posteriore.

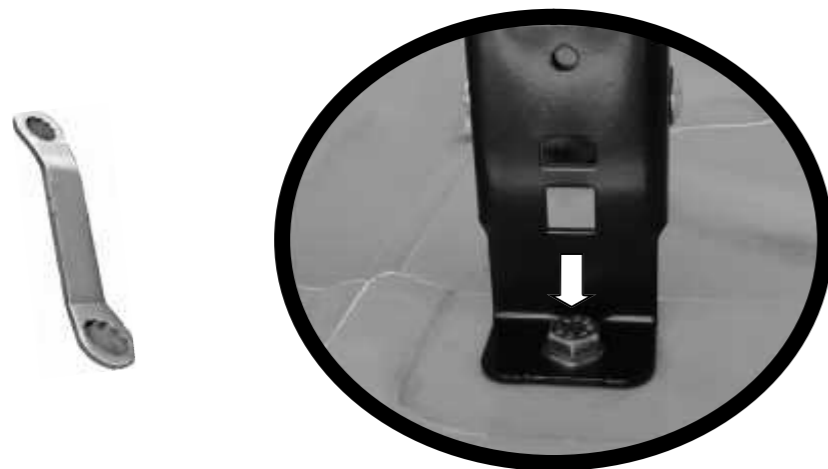

I: Avvitare F: Visser
GB: Screw E: Tornillo
D: Schrauben



7/C

CITROEN: Jumpy (07>) tetto alto.
PEUGEOT: Expert (07>) tetto alto.
FIAT: Scudo (07>) tetto alto.

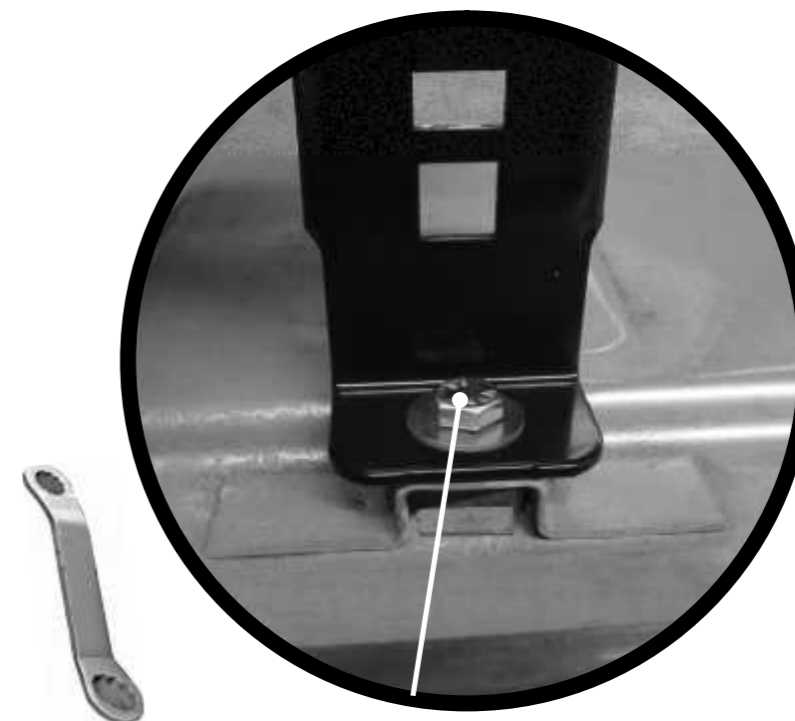

I: Avvitare F: Visser
GB: Screw E: Tornillo
D: Schrauben

